



Restuccia Allestimenti srl, via Olona 8/b, 20039 Canegrate (MI)
P.IVA/C.F. 12884260154 Sede operativa: via Alcide de Gasperi 97,
20017 Rho (MI) Tel: +39 02 22197182 - info@restucciasrl.com

MODULO D'ORDINE TIPOLOGIA STAND PREALLESTITO A NOLEGGIO
PRE-FITTED STAND TYPE ORDER FORM FOR RENTAL

Stand numero / Stand number _____ Padiglione / Pavilion _____

Ragione sociale / Company name _____

Dati per invio fatturazione / Invoicing address

Ragione sociale / Company name _____

Tel. / Ph. _____ Indirizzo / Address _____

Provincia / Country _____ Città / City _____ CAP / Zip Code _____

P.IVA / V.A.T. / Codice fiscale / Tax Code _____ Codice Univoco _____

Indirizzo e-mail / E-mail address _____

MODULO D'ORDINE / ORDER FORM
TIPOLOGIA STAND PREALLESTITO A NOLEGGIO
PRE-FITTED STAND FOR RENTAL

Da inviare entro il / To be send within 16.01.2024

Indicazioni / Instructions

Il presente modulo, debitamente compilato, dovrà essere inviato unitamente alla copia del pagamento effettuato a Restuccia Allestimenti srl tramite e-mail all'indirizzo tecnico@restucciasrl.com

This form must be returned, duly filled in, to Restuccia Allestimenti srl together with the copy of the payment by e-mail to tecnico@restucciasrl.com

Modalità e termini di pagamento

Bonifico bancario intestato a RESTUCCIA ALLESTIMENTI SRL presso BANCO BPM
Agenzia 4082 - Via Foscolo, 4 - 21052, Busto Arsizio (VA)
ABI 05034 - CAB 22800 - CIN M - C/C 000000012347

IBAN: IT 72 M 05034 22800 0000 0001 2347

SWIFT CODE: BAPPIT21AI2
causale: MY PLANT & GARDEN 2024

By bank transfer made out to RESTUCCIA ALLESTIMENTI SRL BANCO BPM
Agenzia 4082 - Via Foscolo, 4 - 21052, Busto Arsizio (VA)
ABI 05034 - CAB 22800 - CIN M - C/C 000000012347

IBAN: IT 72 M 05034 22800 0000 0001 2347

SWIFT CODE: BAPPIT21AI2
description of payment: MY PLANT & GARDEN 2024

TIPOLOGIA PREALLESTITO PRE-FITTED STAND TYPE	LATI LIBERI OPEN SIDES	M.Q SQ. M	PREZZO UNITARIO (€/M.Q.) UNIT PRICE (€/SQ.M.)	TOTALE TOTAL
SMART			52,00	
ALL INCLUSIVE - SILVER			68,00	
ALL INCLUSIVE - GOLD			70,00	
			TOTALE / TOTAL	
			IVA / VAT 22%	
			TOTALE CON IVA / TOTAL VAT INCLUDED	

*Solo per società con P.IVA italiana, persone fisiche, società estere non in possesso di P.IVA

*Only for companies with italian VAT number, natural persons, foreign companies not in possession of VAT number

NOME AZIENDA DA APPORRE SUL FRONTE DELLO STAND
COMPANY NAME TO BE PLACED ON FRONT STAND

Carpet color choice for "ALL INCLUSIVE" pre-fitted stand type only



In dotazione moquette Elea colore grigio 208
Default Elea carpet grey color 208



Come alternativa, senza costi aggiuntivi, moquette Elea colore verde prato 273, spuntare il riquadro a fianco
At no additional cost, to choose meadow green 273 color carpet, please check the box alongside

TIMBRO E FIRMA
STAMP AND SIGNATURE

LUOGO E DATA
PLACE AND DATE



Restuccia Allestimenti srl, via Olona 8/b, 20039 Canegrate (MI)
P.IVA/C.F. 12884260154 Sede operativa: via Aloide de Gasperi 97,
20017 Rho (MI) Tel: +39 02 22197182 - info@restucciasrl.com

TIPOLOGIA PREALLESSTITO SMART
SMART PRE-FITTED STAND TYPE
Esempio spazio espositivo / Stand example
18 mq/ sq.m
1 lato libero / 1 open side



Descrizione / Description

Pareti con pannelli in legno tamburato h 300 cm,
verniciate di bianco e un telaio in legno frontale
con nome azienda.
Traverse in legno per impianto elettrico.

*Wooden panels painted in white color, h 300 cm.
Frontal wooden frame with company name.
Wooden beams for electrical fittings.*

Impianto Elettrico / Electrical System

- n. 1 QE e cablaggi 3 kW / Main electrical connection 3 kW
- n. 6 Faretti LED / LED Spotlights 150W cad./ each
(luce fredda/ cold light)
- n. 1 Presa multipla 900W / Multiple power socket 900W

Grafica / Graphic

- n. 1 Nome azienda su forex / Company name on PVC panel -
cm 45 x 45

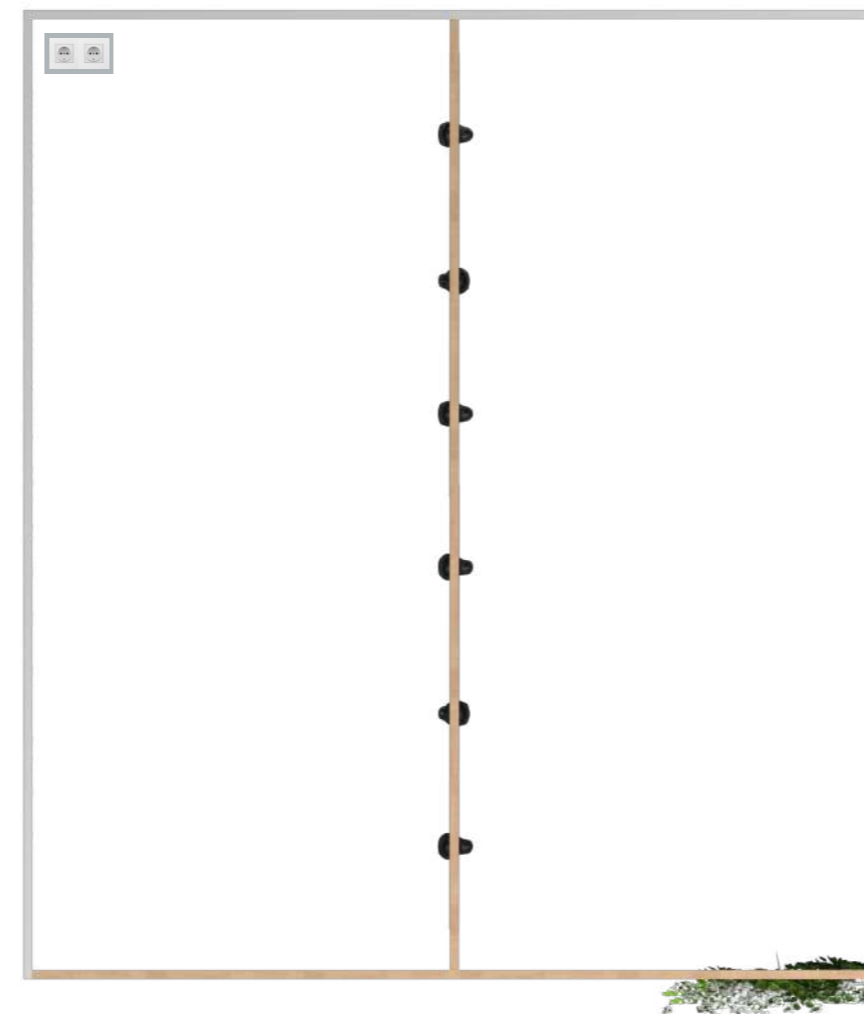

52€/ m.q.

STAND PREALLESSTITO / PRE-FITTED STAND
SMART

L'allestimento tipologia "SMART" è prenotabile via e-mail entro il **16 gennaio 2024**. Contatto e-mail: tecnico@restucciasrl.com/
"SMART" pre-fitted stand can be booked via e-mail within **16 January 2024**. E-mail address: tecnico@restucciasrl.com.
E' possibile aggiungere arredi supplementari alla dotazione tramite il form "Modulo d'ordine optional preallestito "SMART"/
It is possible to order additional supplies using the form "Order form for pre-fitted stand "SMART" optionals"

I colori e le immagini sono puramente indicativi/
Colors and images are indicative only.
Le decorazioni NON sono in dotazione, sono solo un esempio/
The decorations are NOT supplied, they are just an example.



Restuccia Allestimenti srl, via Olona 8/b, 20039 Canegrate (MI)
P.IVA/C.F. 12884260154 Sede operativa: via Alcide de Gasperi 97,
20017 Rho (MI) Tel: +39 02 22197182 - info@restucciasrl.com

TIPOLOGIA PREALLEGITTO SMART
SMART PRE-FITTED STAND TYPE
Esempio spazio espositivo / Stand example
18 mq/ sq.m
2 lati liberi/ 2 open sides



Descrizione / Description

Pareti con pannelli in legno tamburato h 300 cm,
verniciate di bianco e un telaio in legno frontale
con nome azienda.
Traverse in legno per impianto elettrico.

*Wooden panels painted in white color, h 300 cm.
Frontal wooden frame with company name.
Wooden beams for electrical fittings.*

Impianto Elettrico / Electrical System

- n. 1 QE e cablaggi 3 kW / Main electrical connection 3 kW
- n. 6 Faretti LED / LED Spotlights 150W cad./ each
(luce fredda/ cold light)
- n. 1 Presa multipla 900W / Multiple power socket 900W

Grafica / Graphic

- n. 1 Nome azienda su forex / Company name on PVC panel -
cm 45 x 45

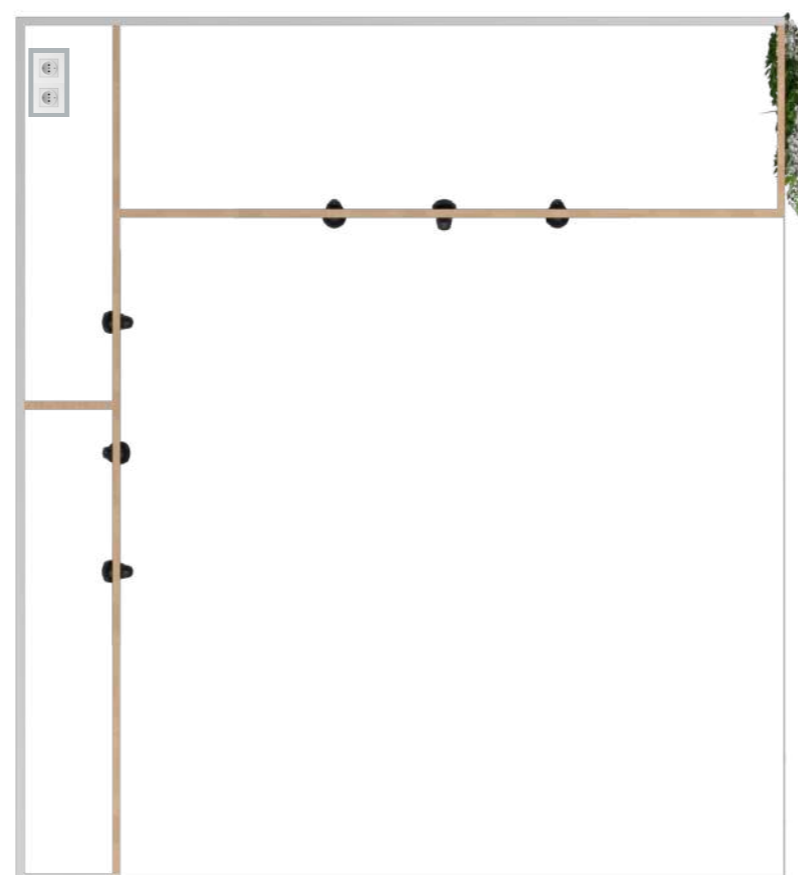
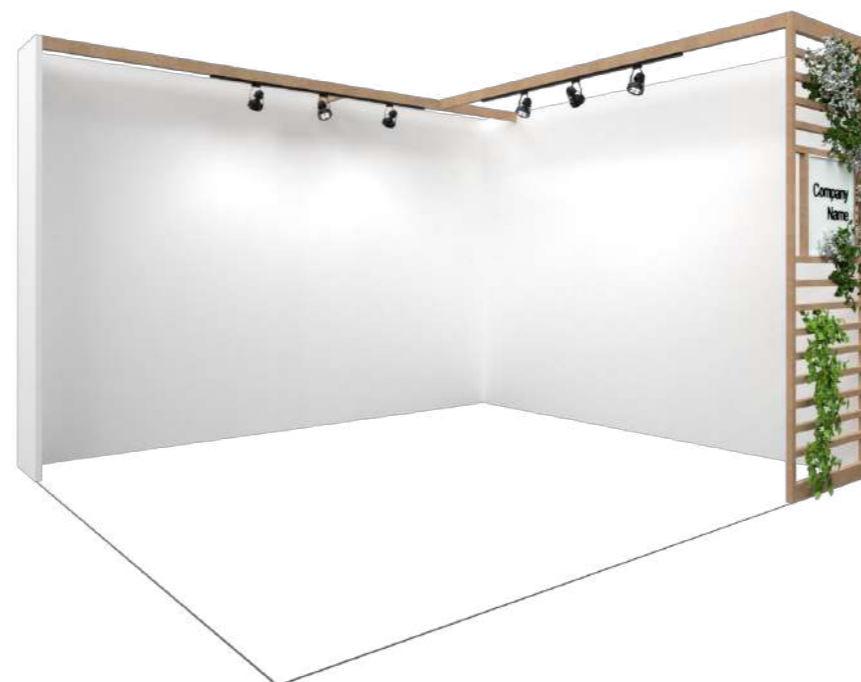
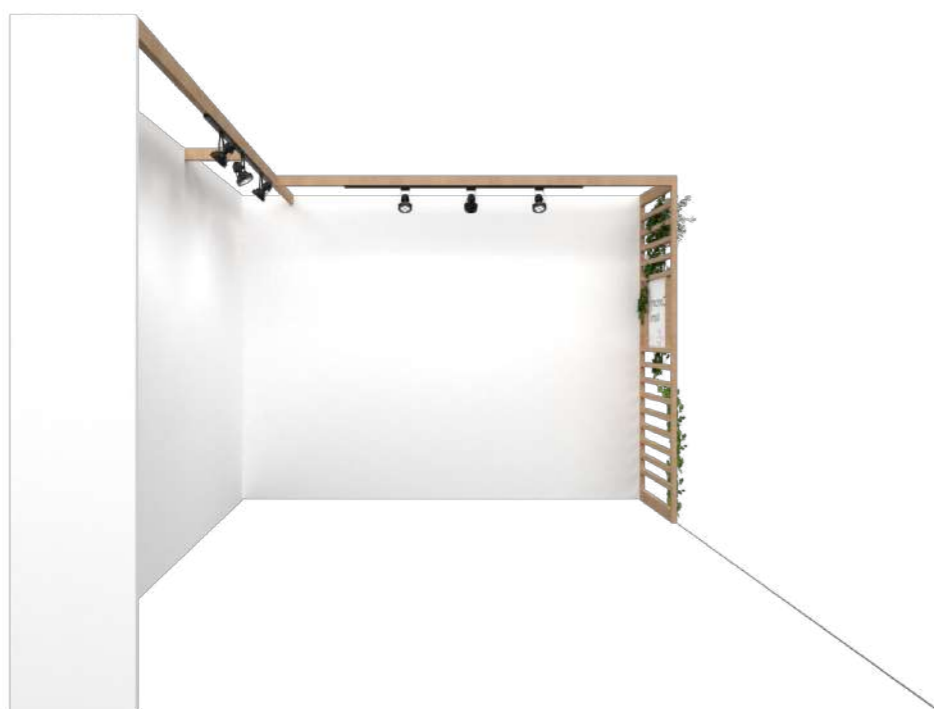

52€/ m.q.

STAND PREALLEGITTO / PRE-FITTED STAND

SMART

L'allestimento tipologia "SMART" è prenotabile via e-mail entro il **16 gennaio 2024**. Contatto e-mail: tecnico@restucciasrl.com/
"SMART" pre-fitted stand can be booked via e-mail within **16 January 2024**. E-mail address: tecnico@restucciasrl.com.
E' possibile aggiungere arredi supplementari alla dotazione tramite il form "Modulo d'ordine optional preallestito "SMART"/
It is possible to order additional supplies using the form "Order form for pre-fitted stand "SMART" optionals"

I colori e le immagini sono puramente indicativi/
Colors and images are indicative only.
Le decorazioni NON sono in dotazione, sono solo un esempio/
The decorations are NOT supplied, they are just an example.

MODULO D'ORDINE OPTIONAL STAND PREALLESTITO "SMART" / ORDER FORM OPTIONAL PRE-FITTED "SMART" STAND

Stand numero / Stand number

Padiglione / Pavilion

Ragione sociale / Company name

Dati per invio fatturazione / Invoicing address

Ragione sociale / Company name

Tel. / Ph.

Indirizzo / Address

Provincia / Country

Città / City

CAP / Zip Code

P.IVA / V.A.T. / Codice fiscale / Tax Code

Codice Univoco

Indirizzo e-mail / E-mail address

Consulta le specifiche di ogni optional alla pagina 5 e riporta qui di seguito le tue scelte / See specifications on page 5 and indicate your choices in table below

	ELENCO OPTIONAL / FURNITURE OPTIONALS	QTÀ / QTY	PREZZO CAD / PRICE EACH	TOTALE / TOTAL
1	Tavolo / Table, cm 150 x 60 x h75		€ 70	
2	Sedia / Chair, cm 40 x 35 x h45		€ 20	
3	Set N°1 tavolo con N°3 sedie / Set N°1 table with N°3 chairs, cm 150 x 60 x h75 e cm 40 x 35 x h45		€ 110	
4	Banco reception / Reception desk, cm 95 x 45 x h100		€ 100	
5	Sgabello alto / High stool, cm 39 x 35 x h75		€ 25	
6	Mensola autoportante / Self-supporting shelf, cm 100 x 50 x h100		€ 100	
7	LOGO in sostituzione al Nome Azienda, misura utile cm 45 x 45 LOGO in sostituzione al Nome Azienda, misura utile cm 45 x 45		€ 29	
8	Cubi in legno verniciati con idropittura bianca			
	cm 50 x 50 x h70		€ 75	
	cm 50 x 50 x h100		€ 90	
	cm 50 x 50 x h120		€ 100	
9	Ripostiglio con chiusura a chiave / Storage room with locker, cm 100 x 50 x h300		€ 110	
10	Ripostiglio con chiusura a chiave / Storage room with locker, cm 100 x 100 x h300		€ 190	
11	Stampa su forex per pareti interne / Customized graphics on PVC board L = cm ----- H = cm -----		€ 45 / mq	
12	Mensola in nobilitato bianco, h da terra da scegliere sotto, cm 26 x 200 Shelf in white laminate, h from ground to be chosen below, cm 26 x 200 <input type="checkbox"/> cm 53 <input type="checkbox"/> cm 83 <input type="checkbox"/> cm 113 <input type="checkbox"/> cm 143		€ 35	
13	Spalla laterale per struttura mensola / Lateral frame for shelf structure, cm 30 x h200		€ 75	
14	Faretto Led / Led Spotlight, 125 W		€ 37	
15	Cestino / Trash basket		€ 5	
16	Presse elettrica multipla / Multiple power socket, 900 W		€ 25	
17	Gancio appendiabiti / Coat hanger		€ 5	
18	Moquette Elea / Elea carpet <input type="checkbox"/> colore grigio 208 / grey color 208 <input type="checkbox"/> colore verde prato 273 / meadow green color 273		€ 7 / mq	
			TOTALE / TOTAL	
			IVA / VAT 22%*	
			TOTALE IVA INCLUSA / TOTAL VAT INCLUDED	

Disponibili fino ad esaurimento scorte / Equipment subject to availability

LUOGO E DATA
PLACE AND DATE

TIMBRO E FIRMA
STAMP AND SIGNATURE



Restuccia Allestimenti srl, via Olona 8/b, 20039 Canegrate (MI)
P.IVA/C.F. 12884260154 Sede operativa: via Alcide de Gasperi 97,
20017 Rho (MI) Tel: +39 02 22197182 - info@restucciasrl.com

MODULO D'ORDINE / ORDER FORM
OPTIONAL PER STAND PREALLESTITO A NOLEGGIO
OPTIONALS FOR PRE-FITTED STAND RENTAL

Da inviare entro il / To be send within 16.01.2024

Indicazioni / Instructions

Il presente modulo, debitamente compilato, dovrà essere inviato unitamente alla copia del pagamento effettuato a Restuccia Allestimenti srl tramite e-mail all'indirizzo tecnico@restucciasrl.com

This form must be returned, duly filled in, to Restuccia Allestimenti srl together with the copy of the payment by e-mail to tecnico@restucciasrl.com

Modalità e termini di pagamento

Bonifico bancario intestato a RESTUCCIA ALLESTIMENTI SRL presso BANCO BPM
Agenzia 4082 - Via Foscolo, 4 - 21052, Busto Arsizio (VA)
ABI 05034 - CAB 22800 - CIN M - C/C 000000012347

IBAN: IT 72 M 05034 22800 0000 0001 2347

SWIFT CODE: BAPPIT21AI2
causale: MY PLANT & GARDEN 2024

By bank transfer made out to RESTUCCIA ALLESTIMENTI SRL BANCO BPM
Agenzia 4082 - Via Foscolo, 4 - 21052, Busto Arsizio (VA)
ABI 05034 - CAB 22800 - CIN M - C/C 000000012347

IBAN: IT 72 M 05034 22800 0000 0001 2347

SWIFT CODE: BAPPIT21AI2
description of payment: MY PLANT & GARDEN 2024

*Solo per società con P.IVA italiana, persone fisiche, società estere non in possesso di P.IVA
*Only for companies with italian VAT number, natural persons, foreign companies not in possession of VAT number

SPECIFICHE PER OPTIONAL PREALLESTITO "SMART"
SPECIFICATIONS FOR PRE-FITTED STAND "SMART"

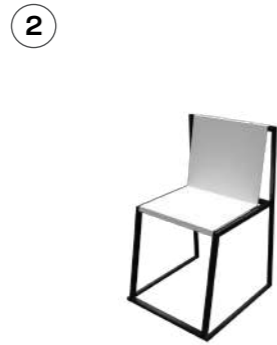

⑦ allega alla e-mail il file con il LOGO in formato vettoriale / please attach to the e-mail the vector file

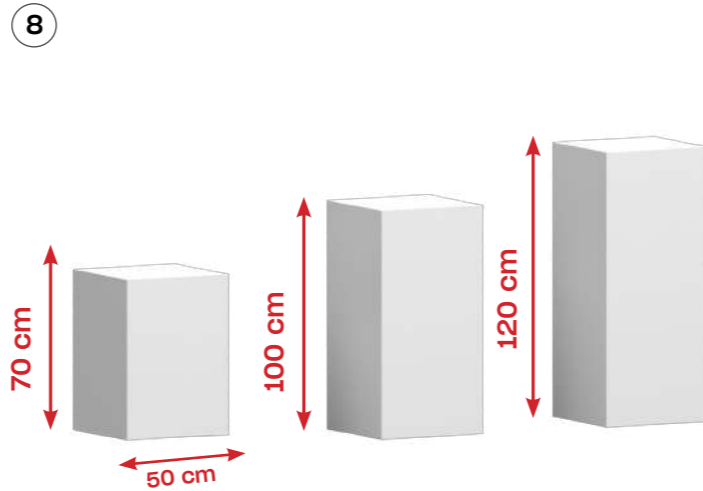

⑨ ⑩ Ripostiglio / storage room

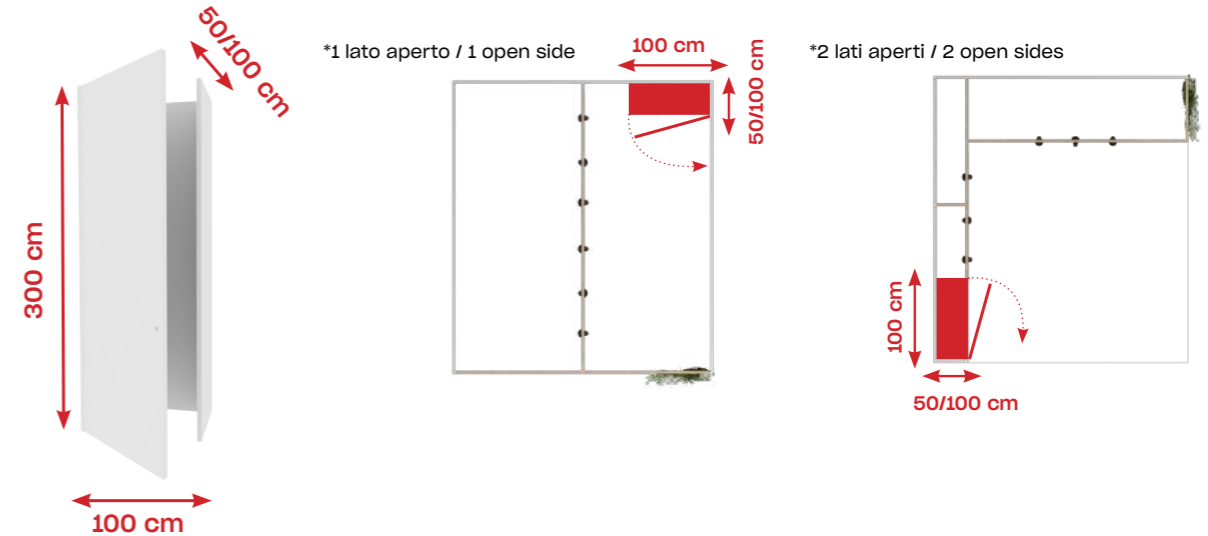

⑪ allega alla e-mail il file in formato vettoriale / please attach to the e-mail the vector file

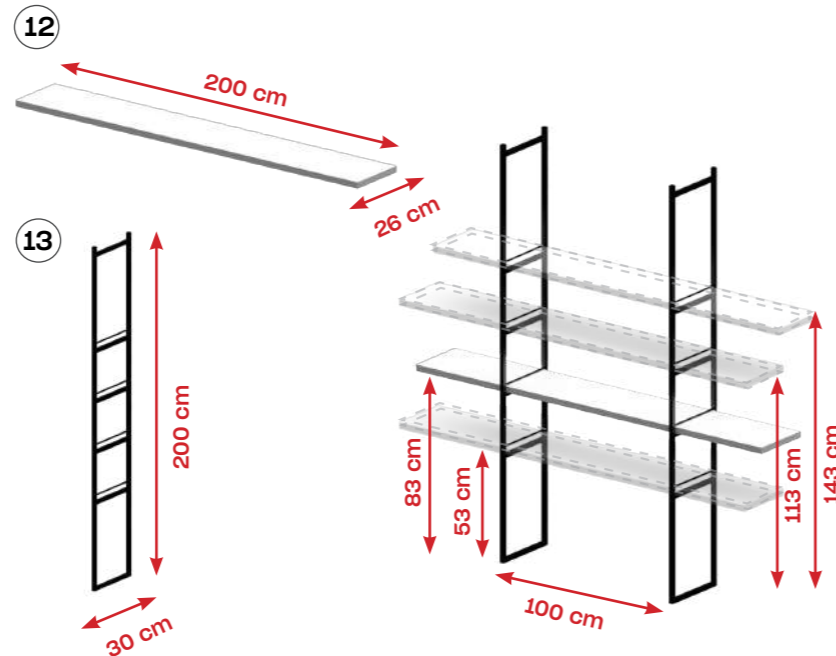
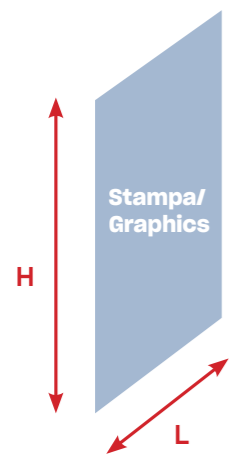

MODULO D'ORDINE TIPOLOGIA STAND PREALLESTITO A NOLEGGIO
PRE-FITTED STAND TYPE ORDER FORM FOR RENTAL



Restuccia Allestimenti srl, via Olona 8/b, 20039 Canegrate (MI)
P.IVA/C.F. 12884260154 Sede operativa: via Alcide de Gasperi 97,
20017 Rho (MI) Tel: +39 02 22197182 - info@restucciasrl.com

Stand numero / Stand number _____ Padiglione / Pavilion _____

Ragione sociale / Company name _____

Dati per invio fatturazione / Invoicing address

Ragione sociale / Company name _____

Tel. / Ph. _____ Indirizzo / Address _____

Provincia / Country _____ Città / City _____ CAP / Zip Code _____

P.IVA / V.A.T. / Codice fiscale / Tax Code _____ Codice Univoco _____

Indirizzo e-mail / E-mail address _____

MODULO D'ORDINE / ORDER FORM
TIPOLOGIA STAND PREALLESTITO A NOLEGGIO
PRE-FITTED STAND FOR RENTAL

Da inviare entro il / To be send within 16.01.2024

Indicazioni / Instructions

Il presente modulo, debitamente compilato, dovrà essere inviato unitamente alla copia del pagamento effettuato a Restuccia Allestimenti srl tramite e-mail all'indirizzo tecnico@restucciasrl.com

This form must be returned, duly filled in, to Restuccia Allestimenti srl together with the copy of the payment by e-mail to tecnico@restucciasrl.com

Modalità e termini di pagamento

Bonifico bancario intestato a RESTUCCIA ALLESTIMENTI SRL presso BANCO BPM
Agenzia 4082 - Via Foscolo, 4 - 21052, Busto Arsizio (VA)
ABI 05034 - CAB 22800 - CIN M - C/C 000000012347

IBAN: IT 72 M 05034 22800 0000 0001 2347

SWIFT CODE: BAPPIT21AI2
causale: MY PLANT & GARDEN 2024

By bank transfer made out to RESTUCCIA ALLESTIMENTI SRL BANCO BPM
Agenzia 4082 - Via Foscolo, 4 - 21052, Busto Arsizio (VA)
ABI 05034 - CAB 22800 - CIN M - C/C 000000012347

IBAN: IT 72 M 05034 22800 0000 0001 2347

SWIFT CODE: BAPPIT21AI2
description of payment: MY PLANT & GARDEN 2024

TIPOLOGIA PREALLESTITO PRE-FITTED STAND TYPE	LATI LIBERI OPEN SIDES	M.Q SQ. M	PREZZO UNITARIO (€/M.Q.) UNIT PRICE (€/SQ.M.)	TOTALE TOTAL
SMART			52,00	
ALL INCLUSIVE - SILVER			68,00	
ALL INCLUSIVE - GOLD			70,00	
			TOTALE / TOTAL	
			IVA / VAT 22%	
			TOTALE CON IVA / TOTAL VAT INCLUDED	

*Solo per società con P.IVA italiana, persone fisiche, società estere non in possesso di P.IVA

*Only for companies with italian VAT number, natural persons, foreign companies not in possession of VAT number

NOME AZIENDA DA APPORRE SUL FRONTE DELLO STAND
COMPANY NAME TO BE PLACED ON FRONT STAND

Carpet color choice for "ALL INCLUSIVE" pre-fitted stand type only



In dotazione moquette Elea colore grigio 208
Default Elea carpet grey color 208

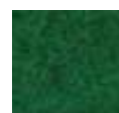

Come alternativa, senza costi aggiuntivi, moquette Elea colore verde prato 273, spuntare il riquadro a fianco
At no additional cost, to choose meadow green 273 color carpet, please check the box alongside

TIMBRO E FIRMA
STAMP AND SIGNATURE

LUOGO E DATA
PLACE AND DATE



Restuccia Allestimenti srl, via Olona 8/b, 20039 Canegrate (MI)
P.IVA/C.F. 12884260154 Sede operativa: via Alcide de Gasperi 97,
20017 Rho (MI) Tel: +39 02 22197182 - info@restucciasrl.com

TIPOLOGIA PREALLESSTITO ALL INCLUSIVE - GOLD
ALL INCLUSIVE - GOLD PRE-FITTED STAND TYPE
Esempio spazio espositivo / Stand example
18 mq/ sq.m
1 lato libero / 1 open side



Descrizione / Description

Moquette Elea in dotazione color grigio.
Su richiesta, senza costi aggiuntivi, è possibile sostituirla con il
colore verde (vedi "Modulo d'ordine tipologia preallestito").
Pareti con pannelli in legno tamburato h 300 cm, verniciate di
bianco.
Traverse in legno per impianto elettrico.

Elea carpet, grey color. On request, at no additional cost, it is
possible to replace it with the green color
(see "Pre-fitted stand type order form").
Wooden panels painted in white color, h 300 cm.
Wooden beams for electrical system.

Dotazione arredi / Furniture

- n. 1 Ripostiglio con chiusura a chiave e gancio appendiabiti /
Storage room with locker and cloth hanger - cm 100 x 50 x h 300
- n. 1 Tavolo / Table - cm 150 x 60 x h 75
- n. 3 Sedie / Chairs
- n. 4 Spalle laterali per strutture mensole / Lateral frames for shelves
- n. 2 Ripiani bianchi / White shelves - cm 200 x 26
- n. 1 Telaio in legno / Wooden frame
- n. 1 Cestino gettacarte / Waste basket

Impianto Elettrico / Electrical System

- n. 1 QE e cablaggi 3 kW / Main electrical connection 3 kW
- n. 6 Faretti LED / LED Spotlights 150 W cad. / each
(luce fredda/ cold light)
- n. 1 Presa multipla 900W / Multiple power socket 900W

Grafica / Graphic

- n. 1 Nome azienda su forex / Company name on PVC panel -
cm 45 x 45

I colori e le immagini sono puramente indicativi/
Colors and images are indicative only.
Le decorazioni NON sono in dotazione, sono solo un esempio/
The decorations are NOT supplied, they are just an example.

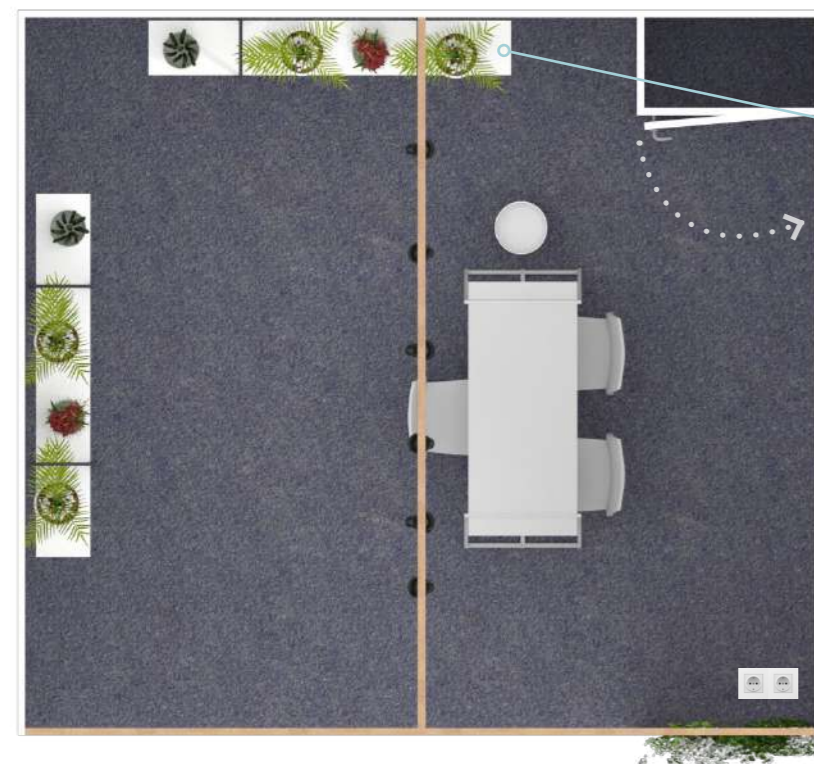

NEW!

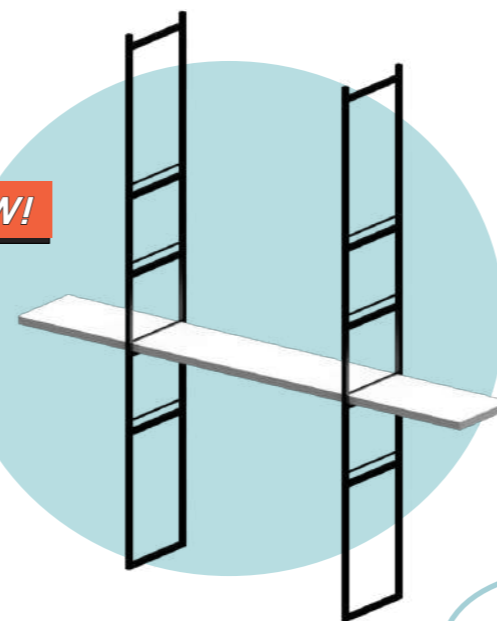

Inclusi nella dotazione di base n. 2 strutture
con n. 1 ripiano e n. 2 spalle ciascuna
*This stand type includes n. 2 structures with
n. 1 shelf and n. 2 lateral frames each*

* È possibile aggiungere delle spalle
laterali o dei ripiani per aumentare lo
spazio espositivo compilando il "Modulo
Optional"

**It is possible to add shelves or lateral
frames to increase the exhibition space
fulfilling the "Optionals" form*

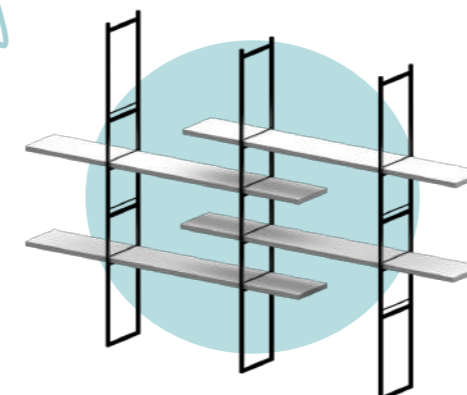
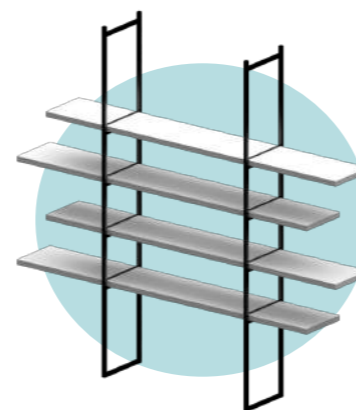

70€/ m.q.

STAND PREALLESSTITO / PRE-FITTED STAND

ALL INCLUSIVE

GOLD

L'allestimento tipologia "ALL INCLUSIVE-GOLD" è prenotabile via e-mail entro il **16 gennaio 2024**. Contatto e-mail: tecnico@restucciasrl.com/
"ALL INCLUSIVE-GOLD" pre-fitted stand can be booked via e-mail within **16 January 2024**. E-mail address: tecnico@restucciasrl.com.
E' possibile aggiungere arredi supplementari alla dotazione tramite il form "Modulo d'ordine optional preallestito "ALL INCLUSIVE-GOLD"/
It is possible to order additional supplies using the form "Order form for pre-fitted stand "ALL INCLUSIVE-GOLD" optionals"



Restuccia Allestimenti srl, via Olona 8/b, 20039 Canegrate (MI)
P.IVA/C.F. 12884260154 Sede operativa: via Alcide de Gasperi 97,
20017 Rho (MI) Tel: +39 02 22197182 - info@restucciasrl.com

TIPOLOGIA PREALLESSTITO ALL INCLUSIVE-GOLD
ALL INCLUSIVE-GOLD PRE-FITTED STAND TYPE
Esempio spazio espositivo / Stand example
18 mq/ sq.m
2 lati liberi/ 2 open sides

Descrizione / Description

Moquette Elea in dotazione color grigio.
Su richiesta, senza costi aggiuntivi, è possibile sostituirla con il colore verde (vedi "Modulo d'ordine tipologia preallestito").
Pareti con pannelli in legno tamburato h 300 cm, verniciate di bianco.
Traverse in legno per impianto elettrico.

Elea carpet, grey color. On request, at no additional cost, it is possible to replace it with the green color (see "Pre-fitted stand type order form").
Wooden panels painted in white color, h 300 cm.
Wooden beams for electrical system.

Dotazione arredi / Furniture

- n. 1 Ripostiglio con chiusura a chiave e gancio appendiabiti / Storage room with locker and cloth hanger - cm 100 x 50 x h 300
- n. 1 Tavolo / Table - cm 150 x 60 x h 75
- n. 3 Sedie / Chairs
- n. 4 Spalle laterali per strutture mensole / Lateral frames for shelves
- n. 2 Ripiani bianchi / White shelves - cm 200 x 26
- n. 1 Telaio in legno / Wooden frame
- n. 1 Cestino gettacarte / Waste basket

Impianto Elettrico / Electrical System

- n. 1 QE e cablaggi 3 kW / Main electrical connection 3 kW
- n. 6 Faretti LED / LED Spotlights 150 W cad. / each (luce fredda/ cold light)
- n. 1 Presa multipla 900W / Multiple power socket 900W

Grafica / Graphic

- n. 1 Nome azienda su forex / Company name on PVC panel - cm 45 x 45

I colori e le immagini sono puramente indicativi/
Colors and images are indicative only.
Le decorazioni NON sono in dotazione, sono solo un esempio/
The decorations are NOT supplied, they are just an example.

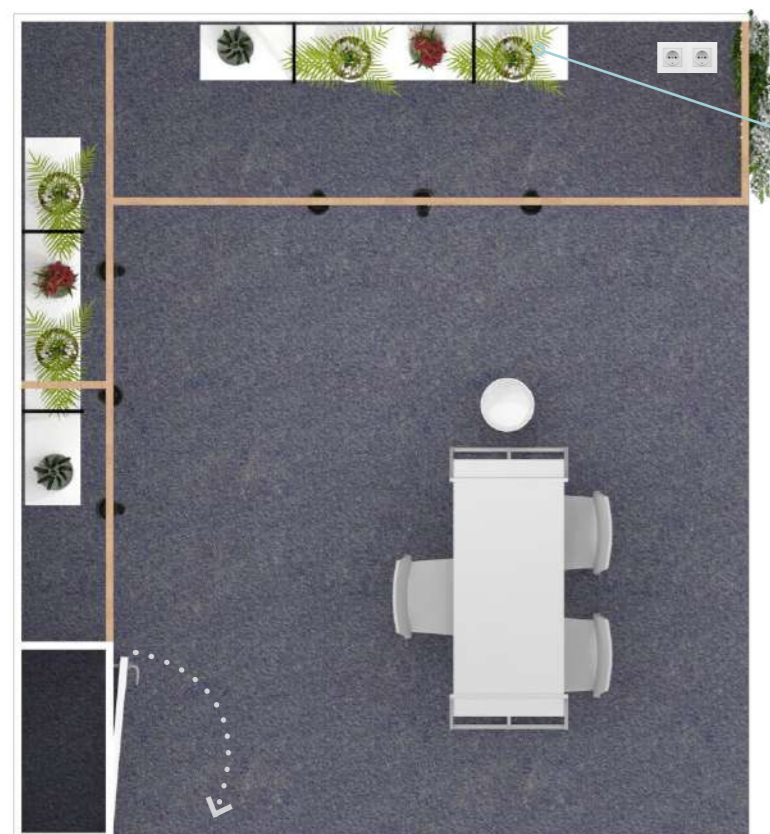

NEW!



Inclusi nella dotazione di base n. 2 strutture con n. 1 ripiano e n. 2 spalle ciascuna
This stand type includes n. 2 structures with n. 1 shelf and n. 2 lateral frames each

* È possibile aggiungere delle spalle laterali o dei ripiani per aumentare lo spazio espositivo compilando il "Modulo Optional"

**It is possible to add shelves or lateral frames to increase the exhibition space fulfilling the "Optionals" form*

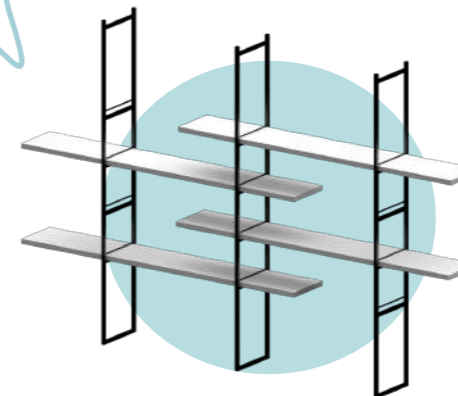
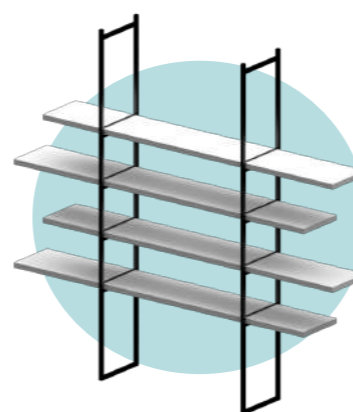

70€/ m.q.

STAND PREALLESSTITO / PRE-FITTED STAND

ALL INCLUSIVE

GOLD

L'allestimento tipologia "ALL INCLUSIVE-GOLD" è prenotabile via e-mail entro il **16 gennaio 2024**. Contatto e-mail: tecnico@restucciasrl.com/
"ALL INCLUSIVE-GOLD" pre-fitted stand can be booked via e-mail within **16 January 2024**. E-mail address: tecnico@restucciasrl.com.
E' possibile aggiungere arredi supplementari alla dotazione tramite il form "Modulo d'ordine optional preallestito "ALL INCLUSIVE-GOLD"/
It is possible to order additional supplies using the form "Order form for pre-fitted stand "ALL INCLUSIVE-GOLD" optionals"



STAND "ALL INCLUSIVE - GOLD" COMPLETO DI ARREDI / STAND "ALL INCLUSIVE - GOLD" WITH FURNITURE

dotazione base, arredi e impianto elettrico in base alla metratura dello stand assegnato / furniture, electrical equipment according to the stand size assigned

Comprendivo di / Including	mq/sqm 18 - 35,5			mq/sqm 36 - 53,5			mq/sqm 54 - 71		
	1 lato libero/ 1 open side	2 lati liberi/ 2 open sides	3 lati liberi/ 3 open sides	1 lato libero/ 1 open side	2 lati liberi/ 2 open sides	3 lati liberi/ 3 open sides	1 lato libero/ 1 open side	2 lati liberi/ 2 open sides	3 lati liberi/ 3 open sides
1 Ripostiglio / Storage room	0,5 x 1 m			1 x 1 m			1 x 1 m		
2 Tavolo / Table cm 150 x 50 x h75	1			2			3		
3 Sedia / Chair cm 40 x 35 x h45	3			6			9		
4 Struttura mensola con 1 ripiano / Display with 1 shelf cm 200 x 26	2			3			4		
5 Gancio appendiabiti / Coat hanger	1			2			2		
6 Cestino / Trash basket	1			2			3		
7 Faretto LED 150 W / LED Spotlight 150 W	6			11			14		
8 Presa multipla 900 W / Multiple Power Socket 900 W	1			2			3		

1



2



3



4

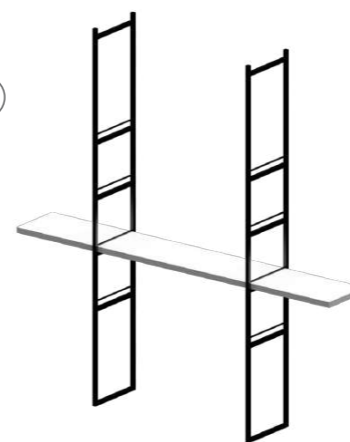

5



6



7



8



**Tipologia Preallestito: ALL INCLUSIVE - GOLD /
Pre-fitted Stand Type: ALL INCLUSIVE - GOLD**

dotazione base (arredi e impianto elettrico) in base alla metratura dello stand assegnato / furniture, electrical equipment according to the stand size assigned

PER OGNI NECESSITÀ
NON PRESENTE NELLE SCHEDE "OPTIONAL",
SCRIVERE AL SEGUENTE INDIRIZZO E-MAIL:
tecnico@restucciasrl.com

FOR ANY OTHER REQUEST NOT PRESENT IN THE
OPTIONAL FORMS, PLEASE WRITE TO THE
FOLLOWING EMAIL ADDRESS:
tecnico@restucciasrl.com

**MODULO D'ORDINE OPTIONAL STAND PREALLESTITO "ALL INCLUSIVE - GOLD" /
ORDER FORM OPTIONAL PRE-FITTED STAND "ALL INCLUSIVE - GOLD"**



Restuccia Allestimenti srl, via Olona 8/b, 20039 Canegrate (MI)
P.IVA/C.F. 12884260154 Sede operativa: via Alcide de Gasperi 97,
20017 Rho (MI) Tel: +39 02 22197182 - info@restucciasrl.com

Stand numero / Stand number _____ Padiglione / Pavilion _____

Ragione sociale / Company name _____

Dati per invio fatturazione / Invoicing address

Ragione sociale / Company name _____

Tel. / Ph. _____ Indirizzo / Address _____

Provincia / Country _____ Città / City _____ CAP / Zip Code _____

P.IVA / V.A.T. / Codice fiscale / Tax Code _____ Codice Univoco _____

Indirizzo e-mail / E-mail address _____

Consulta le specifiche di ogni optional alla pagina 6 e riporta qui di seguito le tue scelte / See specifications on page 6 and indicate your choices in table below

	ELENCO OPTIONAL / FURNITURE OPTIONALS	QTÀ / QTY	PREZZO CAD / PRICE EACH	TOTALE / TOTAL
1	Tavolo / Table, cm 150 x 60 x h75		€ 70	
2	Sedia / Chair, cm 40 x 35 x h45		€ 20	
3	Set N°1 tavolo con N°3 sedie / Set N°1 table with N°3 chairs, cm 150 x 60 x h75 e cm 40 x 35 x h45		€ 110	
4	Banco reception / Reception desk, cm 95 x 45 x h100		€ 100	
5	Sgabello alto / High stool, cm 39 x 35 x h75		€ 25	
6	Mensola autoportante / Self-supporting shelf, cm 100 x 50 x h100		€ 100	
7	LOGO in sostituzione al Nome Azienda, misura utile cm 45 x 45 LOGO in sostituzione al Nome Azienda, misura utile cm 45 x 45		€ 29	
8	Cubi in legno verniciati con idropittura bianca			
	cm 50 x 50 x h70		€ 75	
	cm 50 x 50 x h100		€ 90	
	cm 50 x 50 x h120		€ 100	
9	Ripostiglio con chiusura a chiave / Storage room with locker, cm 100 x 50 x h300		€ 110	
10	Ripostiglio con chiusura a chiave / Storage room with locker, cm 100 x 100 x h300		€ 190	
11	Stampa su forex per pareti interne / Customized graphics on PVC board L = cm _____ H = cm _____		€ 45 / mq	
12	Mensola in nobilitato bianco, h da terra da scegliere sotto, cm 26 x 200 Shelf in white laminate, h from ground to be chosen below, cm 26 x 200		€ 35	
	<input type="checkbox"/> cm 53 <input type="checkbox"/> cm 83 <input type="checkbox"/> cm 113 <input type="checkbox"/> cm 143			
13	Spalla laterale per struttura mensola / Lateral frame for shelf structure, cm 30 x h200		€ 75	
14	Faretto Led / Led Spotlight, 125 W		€ 37	
15	Cestino / Trash basket		€ 5	
16	Presa elettrica multipla / Multiple power socket, 900 W		€ 25	
17	Gancio appendiabiti / Coat hanger		€ 5	

Disponibili fino ad esaurimento scorte / Equipment subject to availability

LUOGO E DATA _____ TIMBRO E FIRMA _____
PLACE AND DATE _____ STAMP AND SIGNATURE _____

TOTALE / TOTAL	
IVA / VAT 22%*	
TOTALE IVA INCLUSA / TOTAL VAT INCLUDED	

**MODULO D'ORDINE / ORDER FORM
OPTIONAL PER STAND PREALLESTITO A NOLEGGIO
OPTIONALS FOR PRE-FITTED STAND RENTAL**

Da inviare entro il / To be send within 16.01.2024

Indicazioni / Instructions

Il presente modulo, debitamente compilato, dovrà essere inviato unitamente alla copia del pagamento effettuato a Restuccia Allestimenti srl tramite e-mail all'indirizzo **tecnico@restucciasrl.com**

*This form must be returned, duly filled in, to Restuccia Allestimenti srl together with the copy of the payment by e-mail to **tecnico@restucciasrl.com***

Modalità e termini di pagamento

Bonifico bancario intestato a RESTUCCIA ALLESTIMENTI SRL presso BANCO BPM
Agenzia 4082 - Via Foscolo, 4 - 21052, Busto Arsizio (VA)
ABI 05034 - CAB 22800 - CIN M - C/C 000000012347

IBAN: IT 72 M 05034 22800 0000 0001 2347

SWIFT CODE: BAPPIT21AI2
causale: MY PLANT & GARDEN 2024

*By bank transfer made out to RESTUCCIA ALLESTIMENTI SRL BANCO BPM
Agenzia 4082 - Via Foscolo, 4 - 21052, Busto Arsizio (VA)
ABI 05034 - CAB 22800 - CIN M - C/C 000000012347*

IBAN: IT 72 M 05034 22800 0000 0001 2347

SWIFT CODE: BAPPIT21AI2
description of payment: MY PLANT & GARDEN 2024

*Solo per società con P.IVA italiana, persone fisiche, società estere non in possesso di P.IVA
*Only for companies with italian VAT number, natural persons, foreign companies not in possession of VAT number

SPECIFICHE PER OPTIONAL PREALLESTITO "ALL INCLUSIVE - GOLD"
SPECIFICATIONS FOR PRE-FITTED STAND "ALL INCLUSIVE - GOLD"

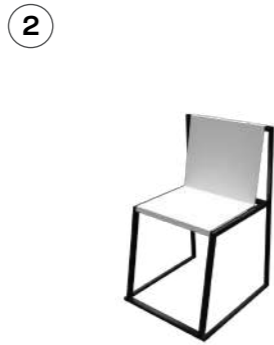

7 allega alla e-mail il file con il LOGO in formato vettoriale / please attach to the e-mail the vector file

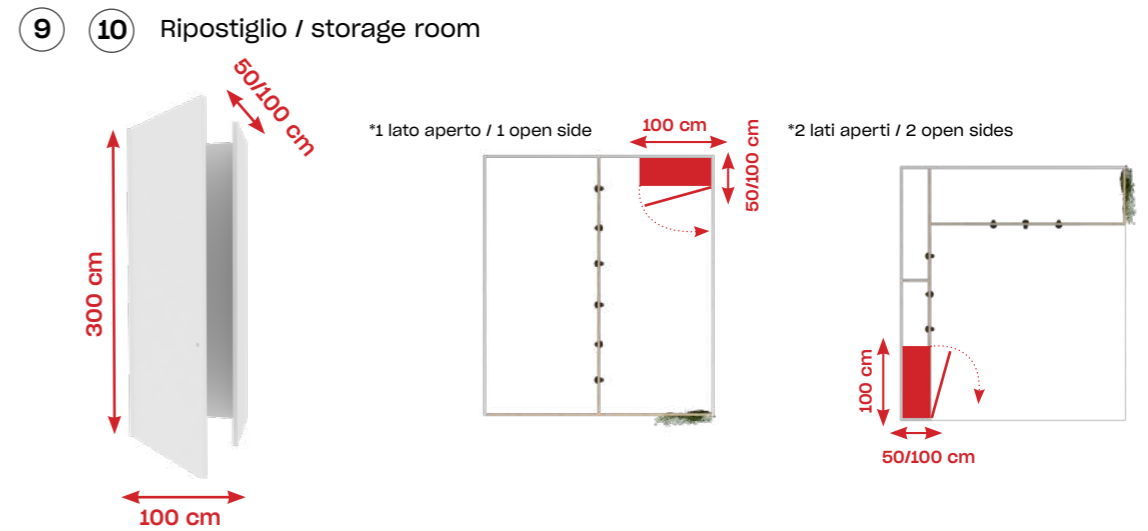
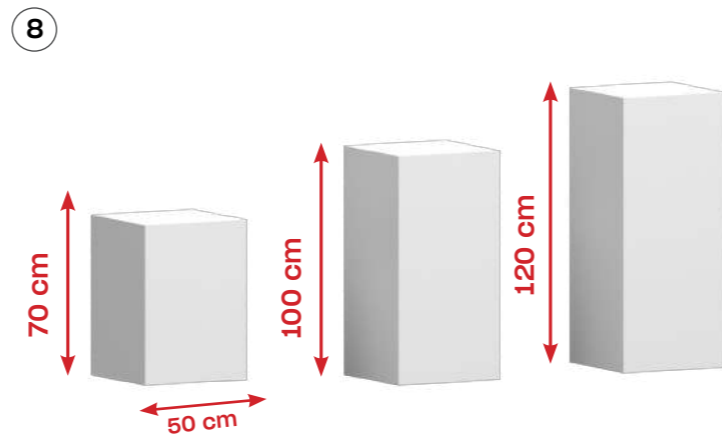

11 allega alla e-mail il file in formato vettoriale / please attach to the e-mail the vector file

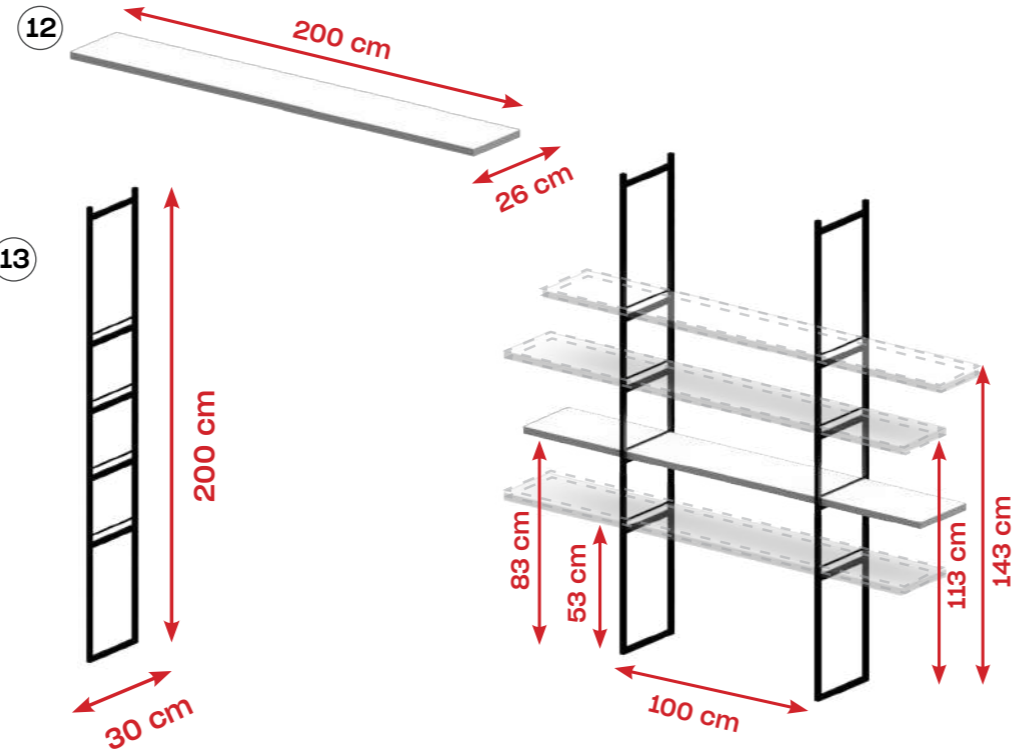
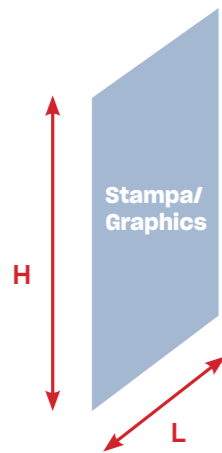

MODULO D'ORDINE TIPOLOGIA STAND PREALLESTITO A NOLEGGIO
PRE-FITTED STAND TYPE ORDER FORM FOR RENTAL



Restuccia Allestimenti srl, via Olona 8/b, 20039 Canegrate (MI)
 P.IVA/C.F. 12884260154 Sede operativa: via Alcide de Gasperi 97,
 20017 Rho (MI) Tel: +39 02 22197182 - info@restucciasrl.com

MODULO D'ORDINE / ORDER FORM
TIPOLOGIA STAND PREALLESTITO A NOLEGGIO
PRE-FITTED STAND FOR RENTAL

Da inviare entro il / To be send within 16.01.2024

Indicazioni / Instructions

Il presente modulo, debitamente compilato, dovrà essere inviato unitamente alla copia del pagamento effettuato a Restuccia Allestimenti srl tramite e-mail all'indirizzo tecnico@restucciasrl.com

This form must be returned, duly filled in, to Restuccia Allestimenti srl together with the copy of the payment by e-mail to tecnico@restucciasrl.com

Modalità e termini di pagamento

Bonifico bancario intestato a RESTUCCIA ALLESTIMENTI SRL presso BANCO BPM
 Agenzia 4082 - Via Foscolo, 4 - 21052, Busto Arsizio (VA)
 ABI 05034 - CAB 22800 - CIN M - C/C 000000012347

IBAN: IT 72 M 05034 22800 0000 0001 2347

SWIFT CODE: BAPPIT21AI2
 causale: MY PLANT & GARDEN 2024

By bank transfer made out to RESTUCCIA ALLESTIMENTI SRL BANCO BPM
 Agenzia 4082 - Via Foscolo, 4 - 21052, Busto Arsizio (VA)
 ABI 05034 - CAB 22800 - CIN M - C/C 000000012347

IBAN: IT 72 M 05034 22800 0000 0001 2347

SWIFT CODE: BAPPIT21AI2
 description of payment: MY PLANT & GARDEN 2024

Stand numero / Stand number _____ Padiglione / Pavilion _____

Ragione sociale / Company name _____

Dati per invio fatturazione / Invoicing address

Ragione sociale / Company name _____

Tel. / Ph. _____ Indirizzo / Address _____

Provincia / Country _____ Città / City _____ CAP / Zip Code _____

P.IVA / V.A.T. / Codice fiscale / Tax Code _____ Codice Univoco _____

Indirizzo e-mail / E-mail address _____

TIPOLOGIA PREALLESTITO PRE-FITTED STAND TYPE	LATI LIBERI OPEN SIDES	M.Q SQ. M	PREZZO UNITARIO (€/M.Q.) UNIT PRICE (€/SQ.M.)	TOTALE TOTAL
SMART			52,00	
ALL INCLUSIVE - SILVER			68,00	
ALL INCLUSIVE - GOLD			70,00	
			TOTALE / TOTAL	
			IVA / VAT 22%	
			TOTALE CON IVA / TOTAL VAT INCLUDED	

*Solo per società con P.IVA italiana, persone fisiche, società estere non in possesso di P.IVA

*Only for companies with italian VAT number, natural persons, foreign companies not in possession of VAT number

NOME AZIENDA DA APPORRE SUL FRONTE DELLO STAND

COMPANY NAME TO BE PLACED ON FRONT STAND

Carpet color choice for "ALL INCLUSIVE" pre-fitted stand type only



In dotazione moquette Elea colore grigio 208
 Default Elea carpet grey color 208

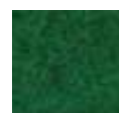

Come alternativa, senza costi aggiuntivi, moquette Elea colore verde prato 273, spuntare il riquadro a fianco
 At no additional cost, to choose meadow green 273 color carpet, please check the box alongside

TIMBRO E FIRMA
 STAMP AND SIGNATURE _____

LUOGO E DATA
 PLACE AND DATE _____



Restuccia Allestimenti srl, via Olona 8/b, 20039 Canegrate (MI)
P.IVA/C.F. 12884260154 Sede operativa: via Alcide de Gasperi 97,
20017 Rho (MI) Tel: +39 02 22197182 - info@restucciasrl.com

TIPOLOGIA PREALLESSTITO ALL INCLUSIVE - SILVER
ALL INCLUSIVE - SILVER PRE-FITTED STAND TYPE
Esempio spazio espositivo / Stand example

18 mq/ sq.m

1 lato libero / 1 open side



Descrizione / Description

Moquette Elea in dotazione color grigio.
Su richiesta, senza costi aggiuntivi, è possibile sostituirla con il colore verde (vedi "Modulo d'ordine tipologia preallestito").
Pareti con pannelli in legno tamburato h 300 cm, verniciate di bianco.
Traverse in legno per impianto elettrico.

Elea carpet, grey color. On request, at no additional cost, it is possible to replace it with the green color (see "Pre-fitted stand type order form").
Wooden panels painted in white color, h 300 cm.
Wooden beams for electrical system.

Dotazione arredi / Furniture

- n. 1 Ripostiglio con chiusura a chiave e gancio appendiabiti / Storage room with locker and cloth hanger - cm 100 x 50 x h 300
- n. 1 Tavolo / Table - cm 150 x 60 x h 75
- n. 3 Sedie / Chairs
- 6,8 ml x 0,50 m Struttura mensola lungo le pareti / Shelf structure along the walls
- n. 1 Telaio in legno / Wooden frame
- n. 1 Cestino gettacarte / Waste basket

Impianto Elettrico / Electrical System

- n. 1 QE e cablaggi 3 kW / Main electrical connection 3 kW
- n. 6 Faretti LED / LED Spotlights 150W cad./each (luce fredda/ cold light)
- n. 1 Presa multipla 900W / Multiple power socket 900W

Grafica / Graphic

- n. 1 Nome azienda su forex / Company name on PVC panel - cm 45 x 45

I colori e le immagini sono puramente indicativi/
Colors and images are indicative only.
Le decorazioni NON sono in dotazione, sono solo un esempio/
The decorations are NOT supplied, they are just an example.



68€/ m.q.

STAND PREALLESSTITO / PRE-FITTED STAND

ALL INCLUSIVE

SILVER

L'allestimento tipologia **"ALL INCLUSIVE-SILVER"** è prenotabile via e-mail entro il **16 gennaio 2024**. Contatto e-mail: tecnico@restucciasrl.com/
"ALL INCLUSIVE-SILVER" pre-fitted stand can be booked via e-mail within **16 January 2024**. E-mail address: tecnico@restucciasrl.com.
E' possibile aggiungere arredi supplementari alla dotazione tramite il form "Modulo d'ordine optional preallestito "ALL INCLUSIVE-SILVER"/
It is possible to order additional supplies using the form "Order form for pre-fitted stand "ALL INCLUSIVE-SILVER" optionals"



Restuccia Allestimenti srl, via Olona 8/b, 20039 Canegrate (MI)
P.IVA/C.F. 12884260154 Sede operativa: via Alcide de Gasperi 97,
20017 Rho (MI) Tel: +39 02 22197182 - info@restucciasrl.com

TIPOLOGIA PREALLESSTITO ALL INCLUSIVE - SILVER
ALL INCLUSIVE - SILVER PRE-FITTED STAND TYPE
Esempio spazio espositivo / Stand example
18 mq/ sq.m
2 lati liberi/ 2 open sides



Descrizione / Description

Moquette Elea in dotazione color grigio.
Su richiesta, senza costi aggiuntivi, è possibile sostituirla con il colore verde (vedi "Modulo d'ordine tipologia preallestito").
Pareti con pannelli in legno tamburato h 300 cm, verniciate di bianco.
Traverse in legno per impianto elettrico.

Elea carpet, grey color. On request, at no additional cost, it is possible to replace it with the green color (see "Pre-fitted stand type order form").
Wooden panels painted in white color, h 300 cm. Wooden beams for electrical system.

Dotazione arredi / Furniture

- n. 1 Ripostiglio con chiusura a chiave e gancio appendiabiti / Storage room with locker and cloth hanger - cm 100 x 50 x h 300
- n. 1 Tavolo / Table - cm 150 x 60 x h 75
- n. 3 Sedie / Chairs
- 6,8 ml x 0,50 m Struttura mensola lungo le pareti / Shelf structure along the walls
- n. 1 Telaio in legno / Wooden frame
- n. 1 Cestino gettacarte / Waste basket

Impianto Elettrico / Electrical System

- n. 1 QE e cablaggi 3 kW / Main electrical connection 3 kW
- n. 6 Faretti LED / LED Spotlights 150W cad./each (luce fredda/ cold light)
- n. 1 Presa multipla 900W / Multiple power socket 900W

Grafica / Graphic

- n. 1 Nome azienda su forex / Company name on PVC panel - cm 45 x 45

I colori e le immagini sono puramente indicativi / Colors and images are indicative only.
Le decorazioni NON sono in dotazione, sono solo un esempio / The decorations are NOT supplied, they are just an example.



68€/ m.q.

STAND PREALLESSTITO / PRE-FITTED STAND

ALL INCLUSIVE

SILVER

L'allestimento tipologia **"ALL INCLUSIVE-SILVER"** è prenotabile via e-mail entro il **16 gennaio 2024**. Contatto e-mail: tecnico@restucciasrl.com/
"ALL INCLUSIVE-SILVER" pre-fitted stand can be booked via e-mail within **16 January 2024**. E-mail address: tecnico@restucciasrl.com.
E' possibile aggiungere arredi supplementari alla dotazione tramite il form "Modulo d'ordine optional preallestito "ALL INCLUSIVE - SILVER"/
It is possible to order additional supplies using the form "Order form for pre-fitted stand "ALL INCLUSIVE - SILVER" optionals"



STAND "ALL INCLUSIVE - SILVER" COMPLETO DI ARREDI / STAND "ALL INCLUSIVE - SILVER" WITH FURNITURE

dotazione base, arredi e impianto elettrico in base alla metratura dello stand assegnato / furniture, electrical equipment according to the stand size assigned

Comprendivo di / Including	mq/sqm 18 - 35,5			mq/sqm 36 - 53,5			mq/sqm 54 - 71		
	1 lato libero/ 1 open side	2 lati liberi/ 2 open sides	3 lati liberi/ 3 open sides	1 lato libero/ 1 open side	2 lati liberi/ 2 open sides	3 lati liberi/ 3 open sides	1 lato libero/ 1 open side	2 lati liberi/ 2 open sides	3 lati liberi/ 3 open sides
1 Ripostiglio / Storage room	0,5 x 1 m			1 x 1 m			1 x 1 m		
2 Tavolo / Table cm 150 x 50 x h75	1			2			3		
3 Sedia / Chair cm 40 x 35 x h45	3			6			9		
4 Struttura mensola lungo le pareti / Shelf structure along the walls	6,8 x 0,5 m			9,9 x 0,5 m			14,8 x 0,5 m		
5 Gancio appendiabiti / Coat hanger	1			2			2		
6 Cestino / Trash basket	1			2			3		
7 Faretto LED 150 W / LED Spotlight 150 W	6			11			14		
8 Presa multipla 900 W / Multiple Power Socket 900 W	1			2			3		

①



②



③



④

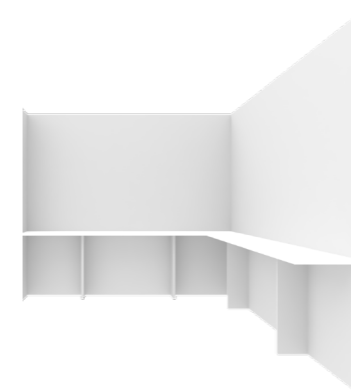

⑤



⑥



⑦



⑧



**Tipologia Preallestito: ALL INCLUSIVE - SILVER /
Pre-fitted Stand Type: ALL INCLUSIVE - SILVER**

dotazione base (arredi e impianto elettrico) in base alla metratura dello stand assegnato / furniture, electrical equipment according to the stand size assigned

PER OGNI NECESSITÀ
NON PRESENTE NELLE SCHEDE "OPTIONAL",
SCRIVERE AL SEGUENTE INDIRIZZO E-MAIL:
tecnico@restucciasrl.com

FOR ANY OTHER REQUEST NOT PRESENT IN THE
OPTIONAL FORMS, PLEASE WRITE TO THE
FOLLOWING EMAIL ADDRESS:
tecnico@restucciasrl.com

**MODULO D'ORDINE OPTIONAL STAND PREALLESTITO "ALL INCLUSIVE - SILVER" /
ORDER FORM OPTIONAL PRE-FITTED STAND "ALL INCLUSIVE - SILVER"**



Restuccia Allestimenti srl, via Olona 8/b, 20039 Canegrate (MI)
P.IVA/C.F. 12884260154 Sede operativa: via Alcide de Gasperi 97,
20017 Rho (MI) Tel: +39 02 22197182 - info@restucciasrl.com

Stand numero / Stand number	Padiglione / Pavilion	
Ragione sociale / Company name		
Dati per invio fatturazione / Invoicing address		
Ragione sociale / Company name		
Tel. / Ph.	Indirizzo / Address	
Provincia / Country	Città / City	CAP / Zip Code
P.IVA / V.A.T. / Codice fiscale / Tax Code	Codice Univoco	
Indirizzo e-mail / E-mail address		

Consulta le specifiche di ogni optional alla pagina 6 e riporta qui di seguito le tue scelte / See specifications on page 6 and indicate your choices in table below

	ELENCO OPTIONAL / FURNITURE OPTIONALS	QTÀ / QTY	PREZZO CAD / PRICE EACH	TOTALE / TOTAL
1	Tavolo / Table, cm 150 x 60 x h75		€ 70	
2	Sedia / Chair, cm 40 x 35 x h45		€ 20	
3	Set N°1 tavolo con N°3 sedie / Set N°1 table with N°3 chairs, cm 150 x 60 x h75 e cm 40 x 35 x h45		€ 110	
4	Banco reception / Reception desk, cm 95 x 45 x h100		€ 100	
5	Sgabello alto / High stool, cm 39 x 35 x h75		€ 25	
6	Mensola autoportante / Self-supporting shelf, cm 100 x 50 x h100		€ 100	
7	Mensola lungo la parete / Shelf along the wall, cm 200 x 50 (solo per gli stand con 1 lato aperto / available only for stands with 1 open side)		€ 100	
8	LOGO in sostituzione al Nome Azienda, misura utile cm 45 x 45 LOGO in sostituzione al Nome Azienda, misura utile cm 45 x 45		€ 29	
9	Cubi in legno verniciati con idropittura bianca			
	cm 50 x 50 x h70		€ 75	
	cm 50 x 50 x h100		€ 90	
	cm 50 x 50 x h120		€ 100	
10	Ripostiglio con chiusura a chiave / Storage room with locker, cm 100 x 50 x h300		€ 110	
11	Ripostiglio con chiusura a chiave / Storage room with locker, cm 100 x 100 x h300		€ 190	
12	Stampa su forex per pareti interne / Customized graphics on PVC board L = cm ----- H = cm -----		€ 45 / mq	
13	Faretto Led / Led Spotlight, 125 W		€ 37	
14	Cestino / Trash basket		€ 5	
15	Presa elettrica multipla / Multiple power socket, 900 W		€ 25	
16	Gancio appendiabiti / Coat hanger		€ 5	
			TOTALE / TOTAL	
			IVA / VAT 22%*	
			TOTALE IVA INCLUSA / TOTAL VAT INCLUDED	

Disponibili fino ad esaurimento scorte / Equipment subject to availability

LUOGO E DATA _____ TIMBRO E FIRMA _____
PLACE AND DATE _____ STAMP AND SIGNATURE _____

**MODULO D'ORDINE / ORDER FORM
OPTIONAL PER STAND PREALLESTITO A NOLEGGIO
OPTIONALS FOR PRE-FITTED STAND RENTAL**

Da inviare entro il / To be send within 16.01.2024

Indicazioni / Instructions

Il presente modulo, debitamente compilato, dovrà essere inviato unitamente alla copia del pagamento effettuato a Restuccia Allestimenti srl tramite e-mail all'indirizzo tecnico@restucciasrl.com

This form must be returned, duly filled in, to Restuccia Allestimenti srl together with the copy of the payment by e-mail to tecnico@restucciasrl.com

Modalità e termini di pagamento

Bonifico bancario intestato a RESTUCCIA ALLESTIMENTI SRL presso BANCO BPM
Agenzia 4082 - Via Foscolo, 4 - 21052, Busto Arsizio (VA)
ABI 05034 - CAB 22800 - CIN M - C/C 000000012347

IBAN: IT 72 M 05034 22800 0000 0001 2347

SWIFT CODE: BAPPIT21AI2
causale: MY PLANT & GARDEN 2024

By bank transfer made out to RESTUCCIA ALLESTIMENTI SRL BANCO BPM
Agenzia 4082 - Via Foscolo, 4 - 21052, Busto Arsizio (VA)
ABI 05034 - CAB 22800 - CIN M - C/C 000000012347

IBAN: IT 72 M 05034 22800 0000 0001 2347

SWIFT CODE: BAPPIT21AI2
description of payment: MY PLANT & GARDEN 2024

*Solo per società con P.IVA italiana, persone fisiche, società estere non in possesso di P.IVA
*Only for companies with italian VAT number, natural persons, foreign companies not in possession of VAT number

SPECIFICHE PER OPTIONAL PREALLESTITO "ALL INCLUSIVE - SILVER"
SPECIFICATIONS FOR PRE-FITTED STAND "ALL INCLUSIVE - SILVER"



⑦ solo con gli stand con 1 lato aperto / available only for stands with 1 open side

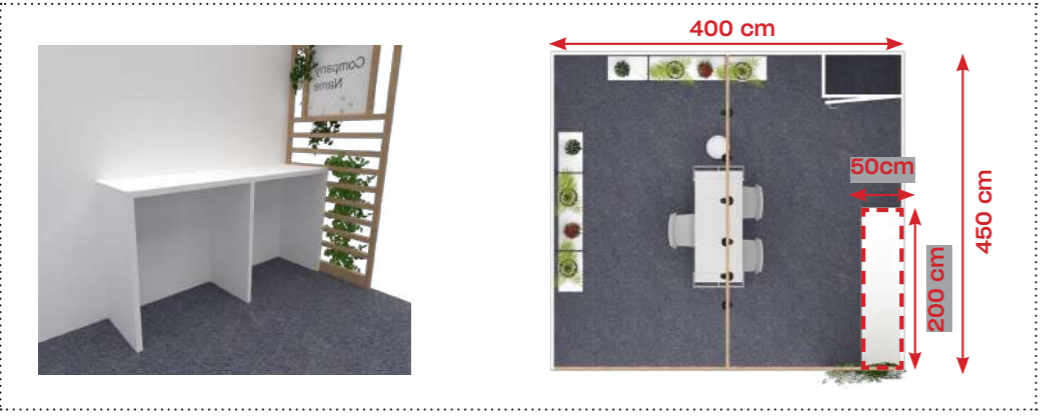

⑧ allega alla e-mail il file con il LOGO in formato vettoriale / please attach to the e-mail the vector file

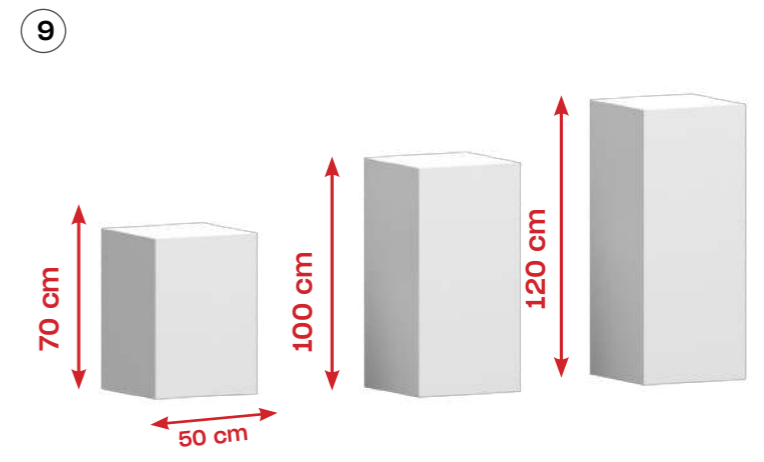

⑩ ⑪ Ripostiglio / storage room

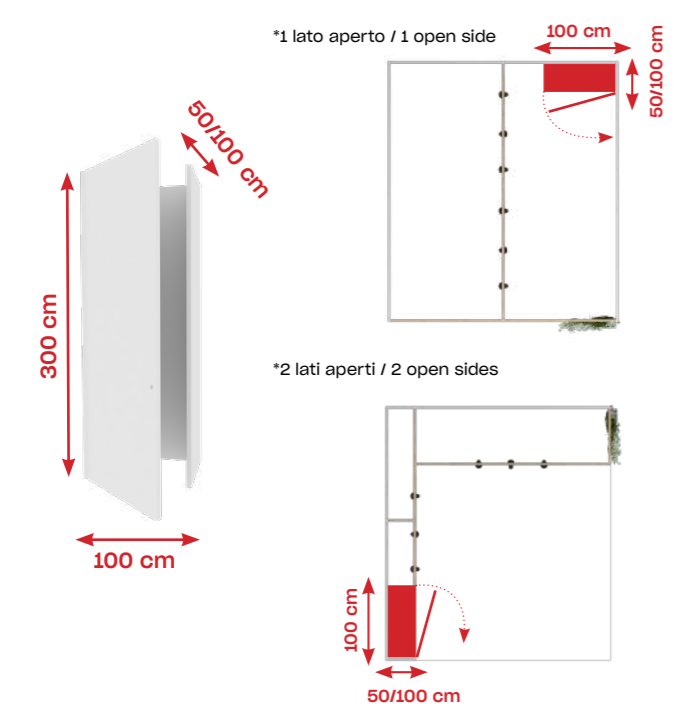

⑫ allega alla e-mail il file in formato vettoriale / please attach to the e-mail the vector file

